







CODE NO: 1470B 4'6" REBECCA BEDSTEAD ANTIQUE BRASS  
 CODE NO: 1476B 5' REBECCA BEDSTEAD ANTIQUE BRASS  
 CODE NO: 1460B 4'6" REBECCA BEDSTEAD NICKEL FINISH  
 CODE NO: 1466B 5' REBECCA BEDSTEAD NICKEL FINISH

<b>A</b>		4PCS	TOP FINIAL
<b>B</b>		4PCS	BUN FOOT
<b>C</b>		9PCS	RUBBER WASHER
<b>D</b>		9PCS	METAL WASHER
<b>E</b>		9PCS	5/16"*1"L SCREW
<b>F</b>		1PC	HEX.WRENCH

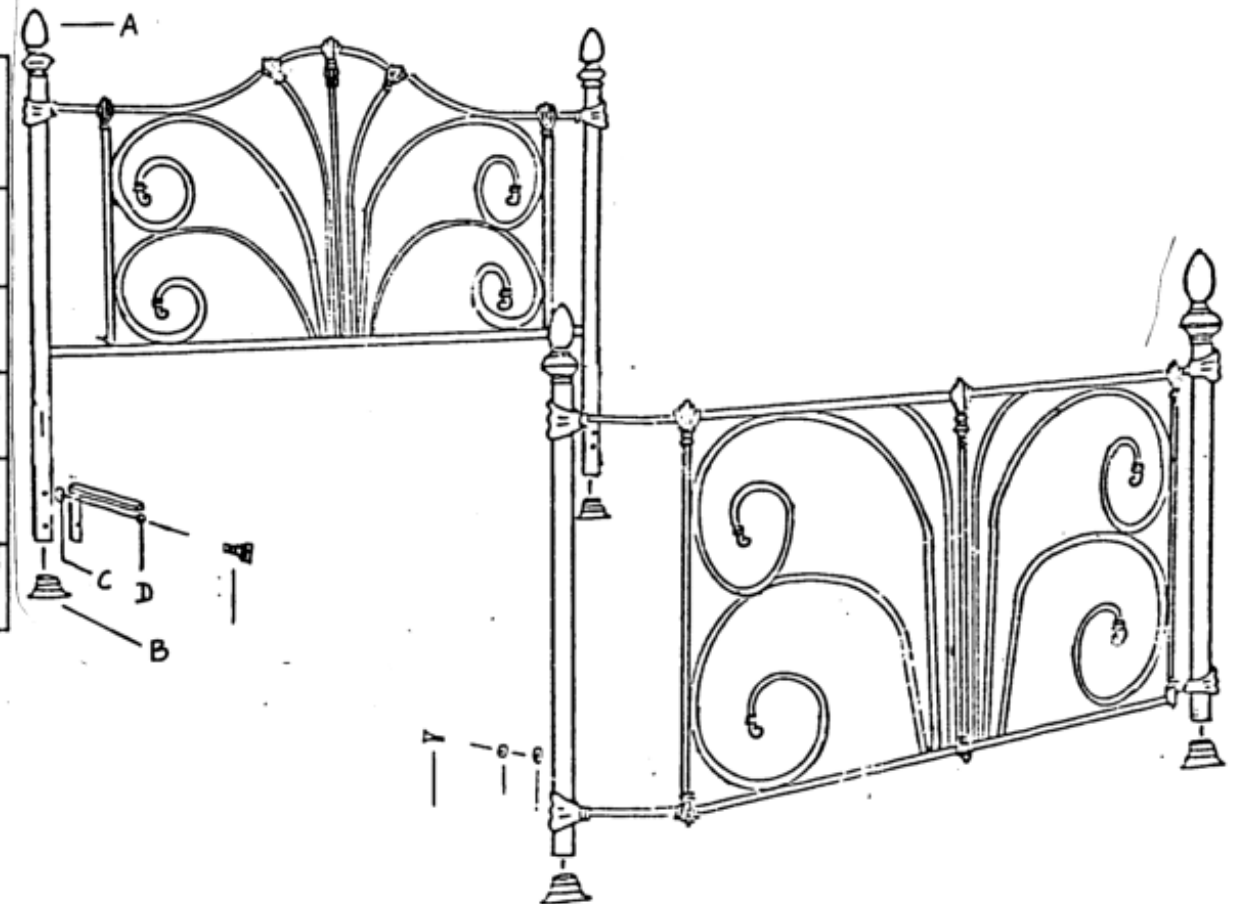

**BENTLEY DESIGNS(U.K)LIMITED**

# ASSEMBLY INSTRUCTION METAL SPRUNG SLAT BASE

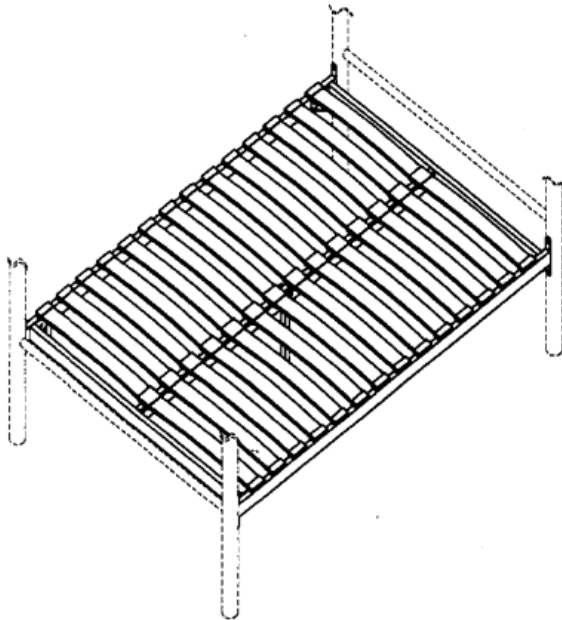

135 CM : W 1341 x D 1920 x H 140  
 150 CM : W 1511 x D 2020 x H 140  
 180 CM : W 1817 x D 2020 x H 140

- Keep hardware and small parts out of children's reach.
- Wipe clean with a damp cloth only.
- Keep these instructions for future reference.
- Periodically check and re-tighten fixings if necessary.

## HARDWARE

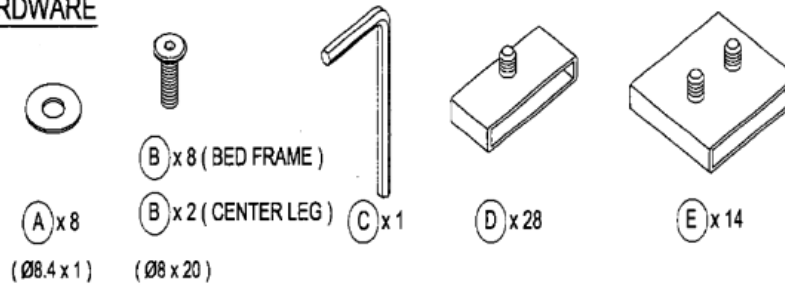

## PARTS

