

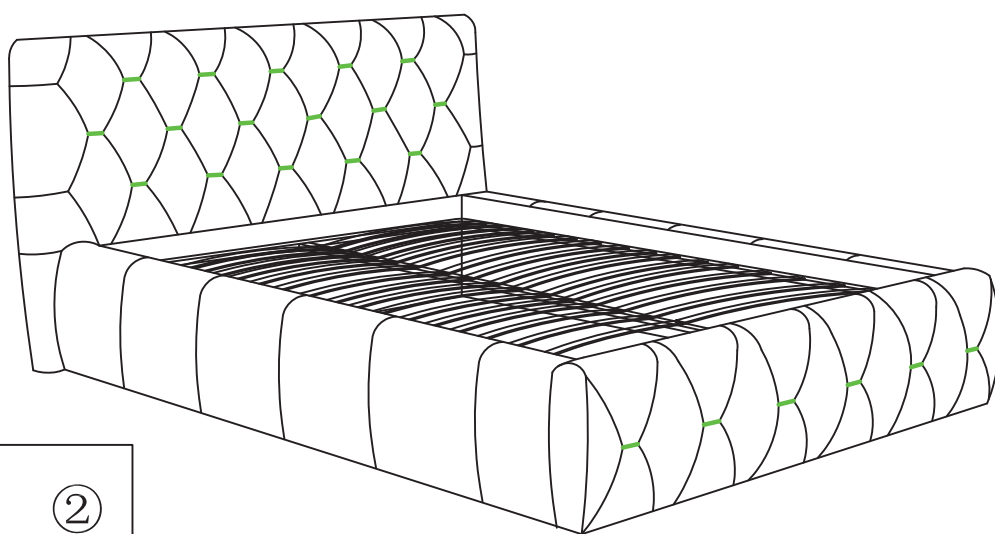

BRESCIA

Double / King / Superking

Assembly Instructions



Minimum No. of people recommended to assemble this product :

2

Approx assembly time :

1/2
hour

NOTE: It will require two people to assemble this bed. Assembly should be carried out in the room that the bed will be used in.

Before you

Start, here











is some

helpful advice:

1. We suggest you spend a short time reading through this leaflet and then follow the simple step by step instructions.
2. Do not discard any of the packaging until you have checked that you have all the parts and the pack of fittings.
3. To ensure an easier assembly, we strongly advise that all fittings are only finger tightened during initial assembly. Only upon completion of the assembly should all fixing points be fully tightened.
4. We recommend a periodic check on all fixing points to make sure they remain fully tightened.
5. Keep glue and fittings out of children's reach.

In the unlikely event that this product has missing or damaged parts, please call 0844 292 0000 and select 4 to obtain spares

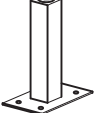
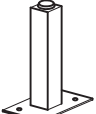
Component parts and fittings contained in the box

PARTS	Fittings
<p>1 1 piece</p> <p>2 1 piece</p> <p>3 2 pieces</p> <p>A</p> <p>B</p>	<p>A  (4pcs) Plastic Washer (4pcs)</p>
	<p>B  (4pcs) Feet (4pcs)</p>
	<p>C  (8pcs) M8 x 18 Bolts (8pcs)</p>
	<p>D  (1pc) Allen Key (m5) (1pc)</p>
	<p>E  (4pcs) M6 x 25 Bolts (4pcs)</p>
	<p>F  (4pcs) M6 x 12 Bolts (4pcs)</p>
	<p>G  (4pcs) Ø6 x 19 Washer (4pcs)</p>
	<p>H  (4pcs) Ø8 x 19 Washer (4pcs)</p>
	<p>I  (6pcs) Screw (6pcs)</p>
	<p>J  (1pc) (1pc)</p>
	<p>K  (2pcs) (2pcs)</p>
	<p>L  (8pcs) Leg securing Bolts (8pcs)</p>
	<p>M  (2pcs) Allen Key (m4) (2pcs)</p>

ASSEMBLY

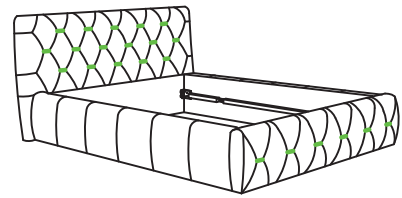

1) Loosen the bolts from the Headboard (1) and footboard (2).

NOTE: Merely loosen the bolts (C), do not take out.

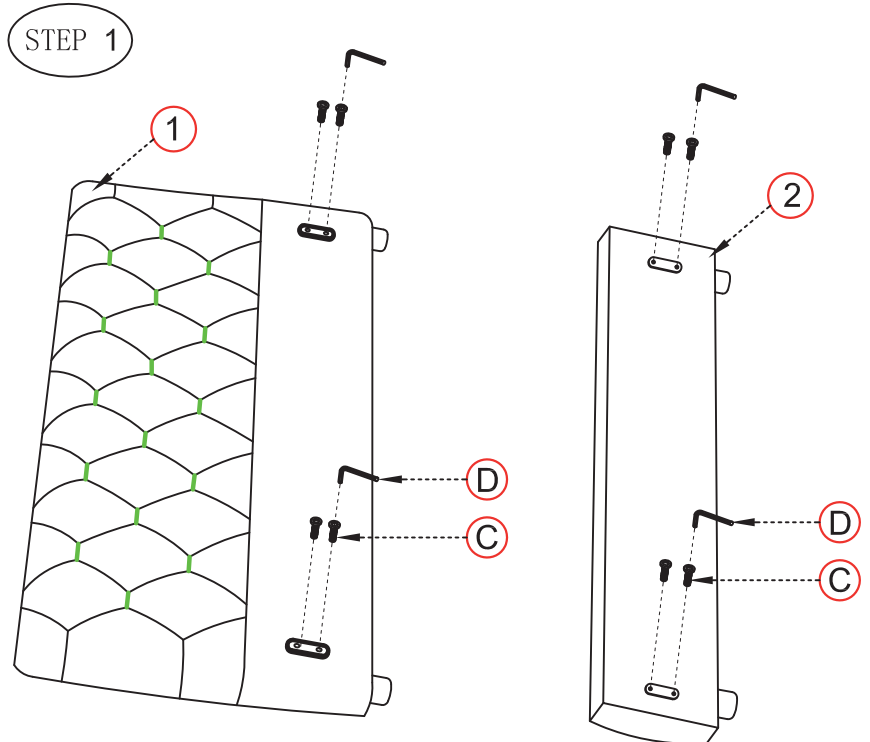

1) Fit the side rail (3) to the head & footboard (1&2) slotting the pre-fitted brackets together as shown. Then use a wrench (D) to tighten bolts (C).

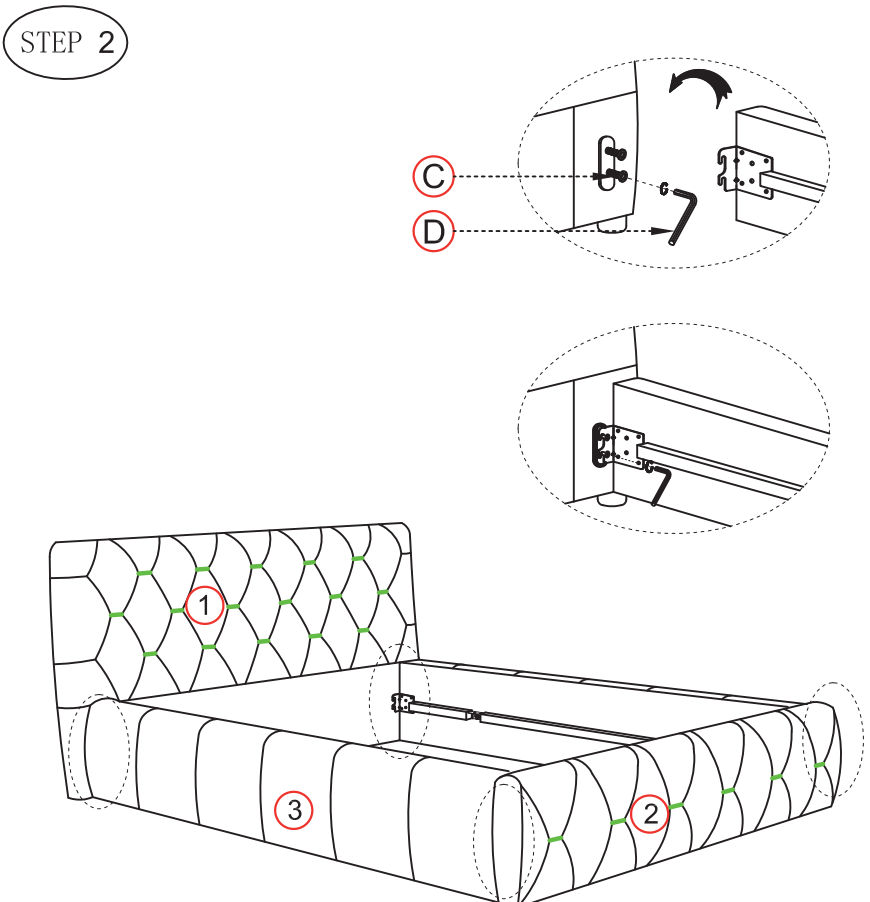

Remark:

Please Proceed to Page 4 for instructions to fit the Sprung Slat System or Page 5 to fit the Solid Slat System.

ASSEMBLY

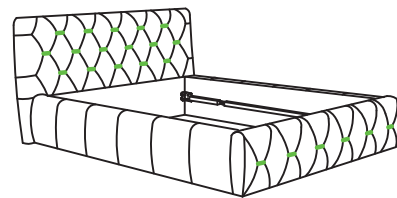

SPRUNG SLAT SYSTEM

- 1) Fix the Legs (J / K) to the slat frame using bolts (L).

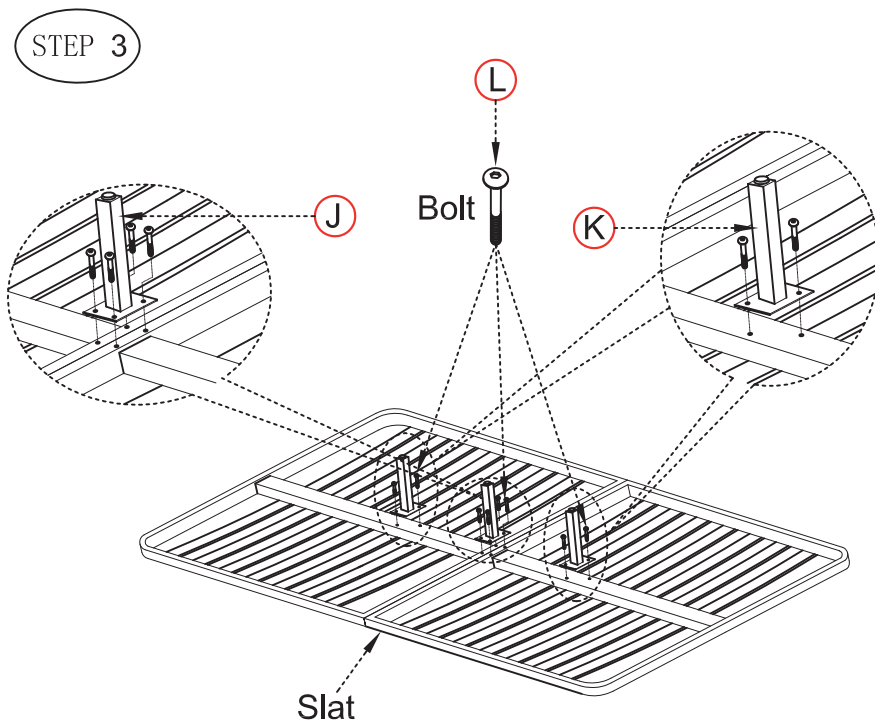

SPRUNG SLAT SYSTEM

- 1) Carefully place the slat frame onto the bed.
- 2) Use bolt (E) and bolt (F) to fix the Slat frame onto the bed.

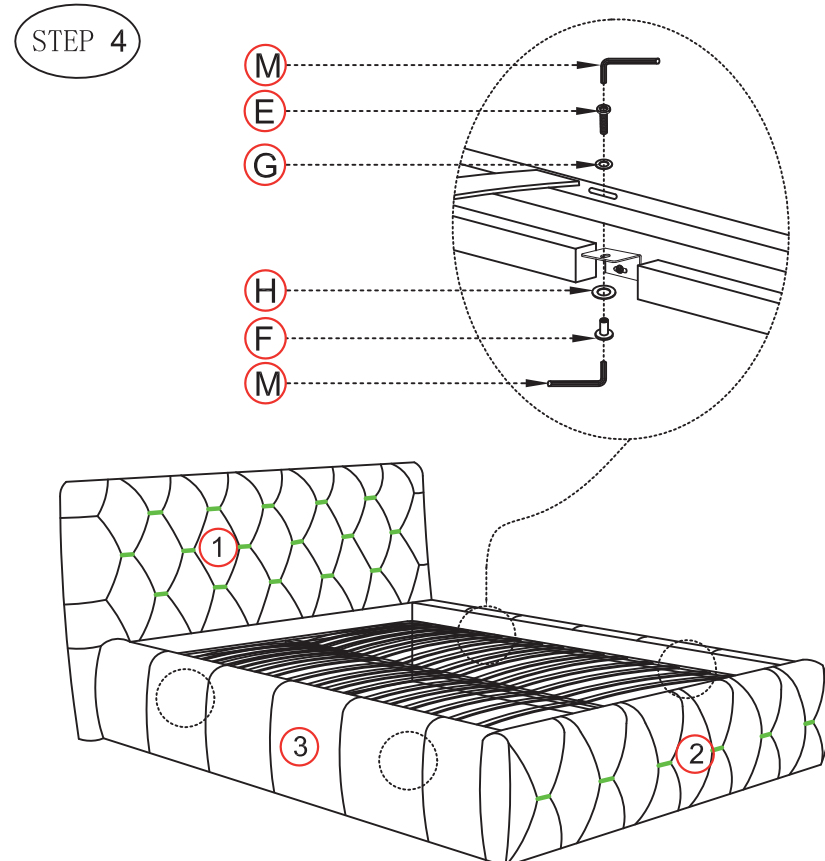

ASSEMBLY

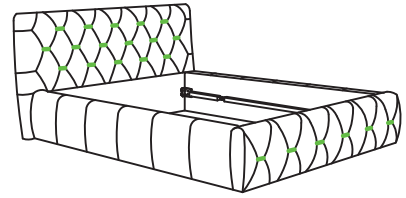

DREAMS FIXED WOOD SLAT SYSTEM

Position the solid wood slat so that the holes in the slats align with those in the side rails (3). Secure the solid wood slats to the side rails (3) by threading screw (1). Finally, tighten screw (1) using a screwdriver into the side rails (3). (See Insert 3)

STEP 3

