

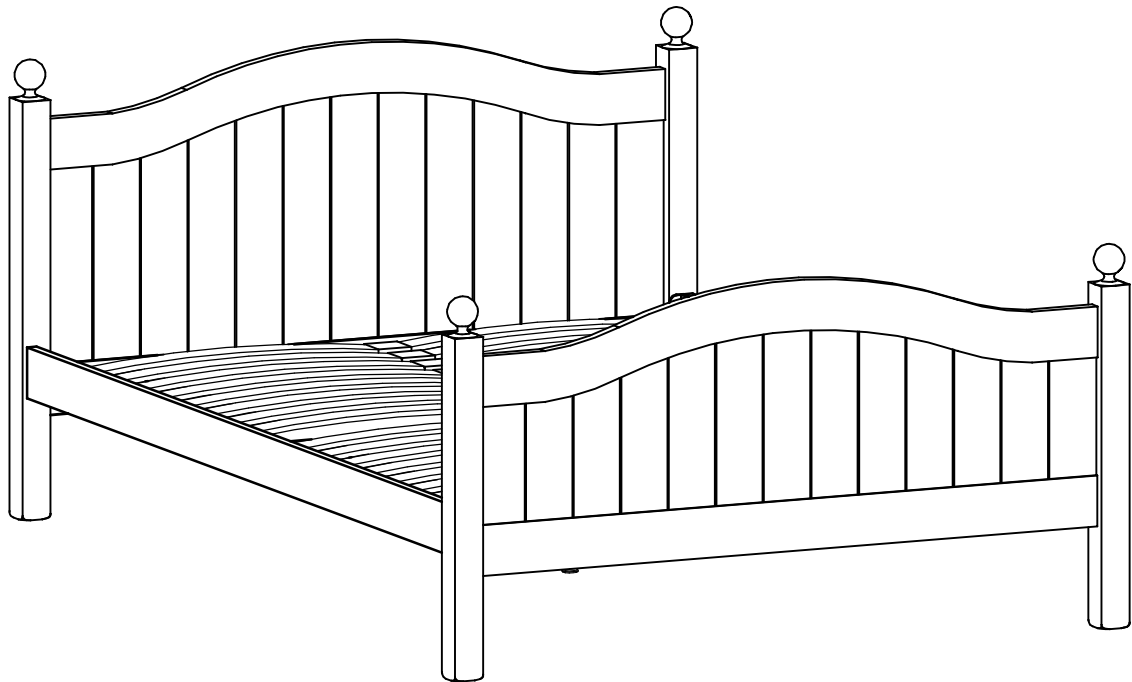

BOLOGNA BED

221-00048

# Assembly Instructions



Note: It will require two people to assemble this bed. Assembly should be carried out in the room the bed will be used in

**Before you  
Start, here is  
some helpful  
advice**

1. We suggest you spend a short time reading through this leaflet and then follow the simple step by step instructions.
2. If you follow the instructions care fully the end result should be worth the effort.
3. Do not discard any of the packaging until you have checked that you have all the parts and the pack of fittings.
4. Assemble this product on a carpet.
5. To ensure an easier assembly, we strongly advise that all fittings are only finger tightened during initial assembly. Only upon completion of the assembly should all fixing points be fully tightened.
6. We recommend a periodic check on all fixing points to make sure they remain fully tightened.
7. Keep glue and fittings out of children's reach.



In the unlikely event that this product has missing or damaged parts, please call 0844 8118 221 to obtain spares.

# Component parts and fittings contained in the box 1

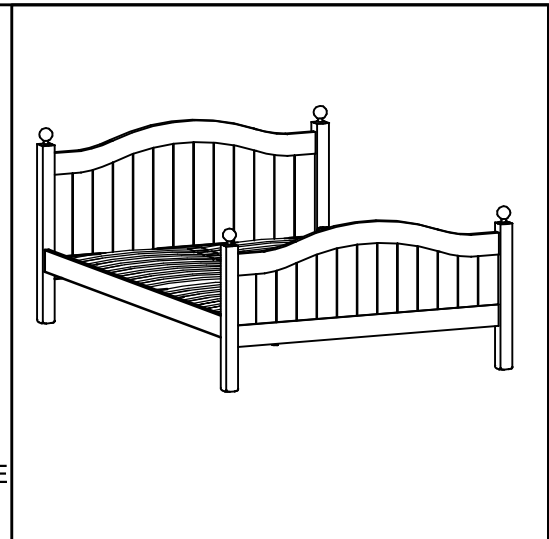
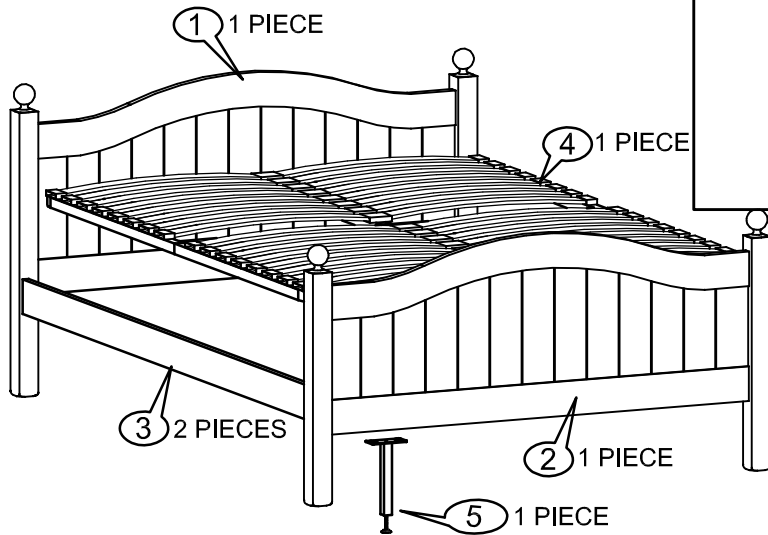
## PARTS

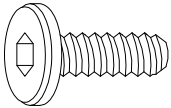
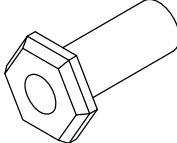
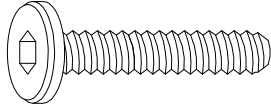

## FITTINGS

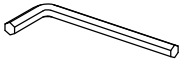
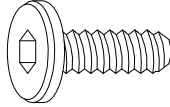
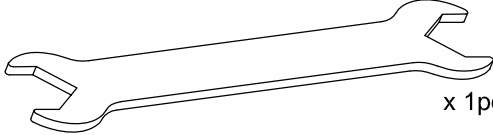
<p><b>C</b>  (M6x20) x 4pcs</p>	<p><b>E</b>  (M6) x 6pcs</p>
<p><b>D</b>  (M6x35) x 6pcs</p>	<p><b>F</b>  (Ø6) x 6pcs</p>
	<p><b>G</b>  (4mm) x 1pc</p>
	<p><b>H</b>  (M6x20) x 8pc</p>
	<p><b>J</b>  x 1pc</p>

# ASSEMBLY

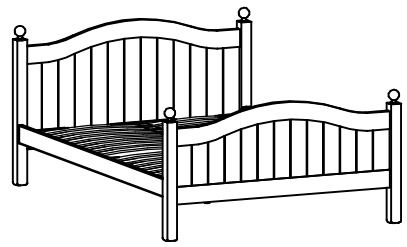

Connect the headboard **1**,  
footboard **2** and the side rails  
**3** using Allen bolts **H**

**STEP 1**

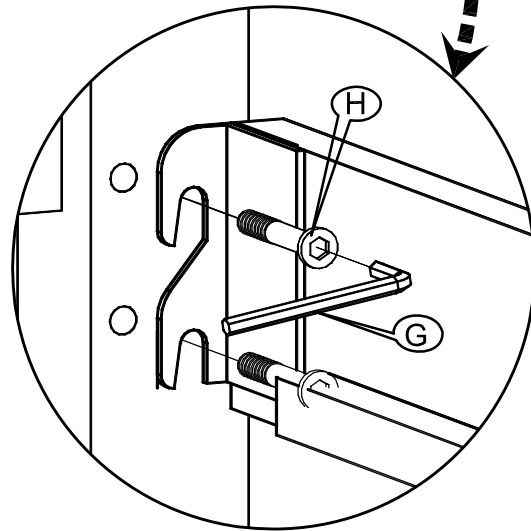
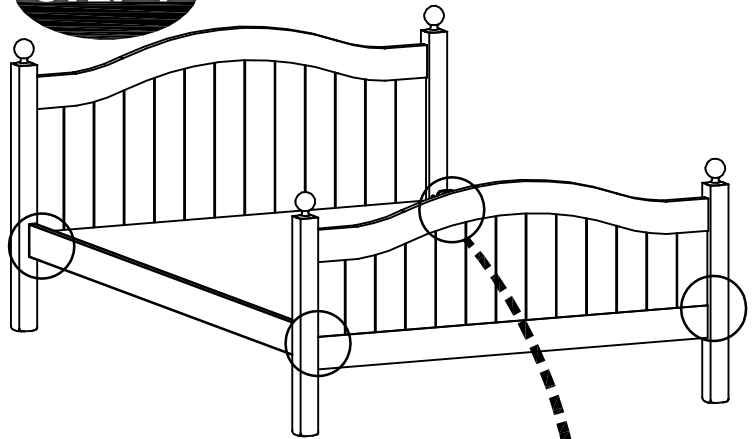

# ASSEMBLY

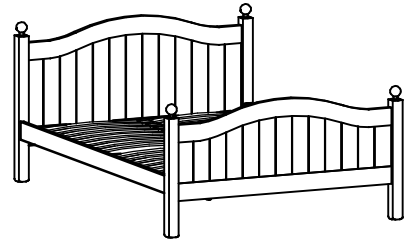

## DREAMS SPRUNG SLAT SYSTEM

Open the metal Slat Frame outwards. Attach Support Legs 5 to the frame and secure using Bolts C. Tighten using Allen Key G. Carefully lower the Slat frame into the bed. With Slats facing upwards. Ensure that the frame sits on the guides located on the Side Rails 3

### STEP 2

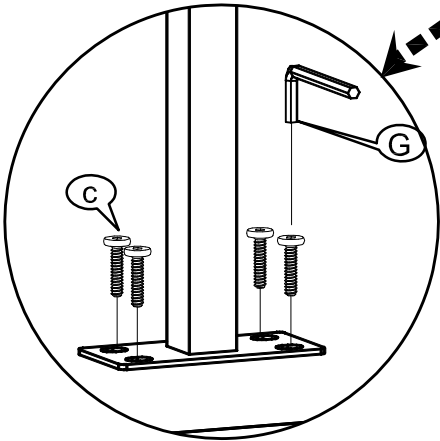
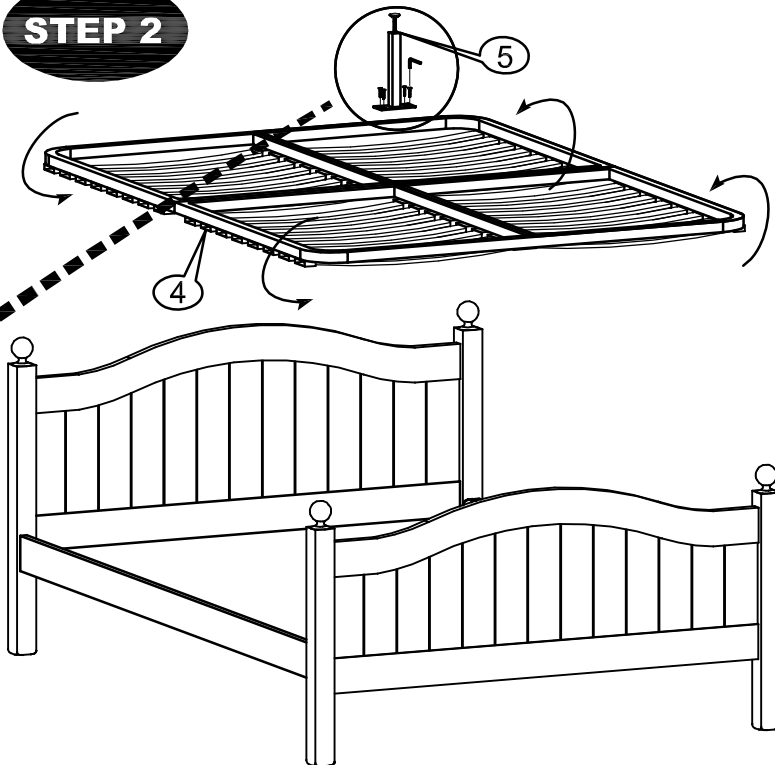

## DREAMS SPRUNG SLAT SYSTEM

Position the Slat frame so that the holes in the frame align with these in the Side Rails 3. Secure the Frame to the Side Rails by threading Bold D through washers F and through the holes in the frame and the Side Rails. Finally, tighten by JCN Nut E on the bolt D from the under side of the side rail, as shown

### STEP 3

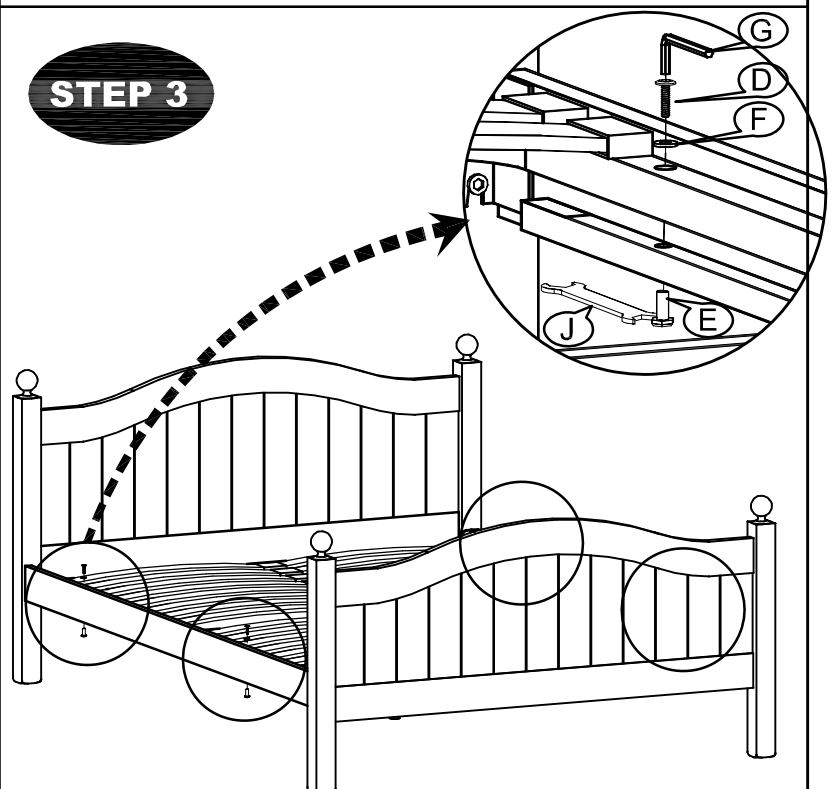

# ASSEMBLY

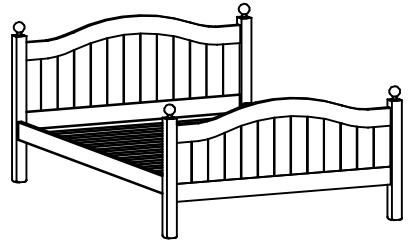

## SOLID WOOD SLATS

Position the solid Wood Slat so that the holes in the Slats align with those in the Side Rails **3**. Secure the solid Wood Slats to the Side Rails by threading Bolt **D** through Washer **F** and through the holes in the slats and the Side Rails. Finally, tighten by JCN Nut **E** onto the Bolt **D** from the underside of the Side Rails, as show

**STEP 4**

