

IMPORTANT - READ CAREFULLY - KEEP FOR FUTURE REFERENCE

- a) **WARNING** Raised beds and the upper bed in a bunk bed assembly are not good for children under 6 years old because of the risk of injury from falling from such beds,
- b) **WARNING** If the raised and bunk beds are not used correctly, they can present a serious risk of injury from strangulation. Never attach or suspend things from the upper bunk bed that are not going to be used with that bed.
Such things include - but are not limited to - cords, string, sashes, hooks, belts and bags.
- c) **WARNING** Children can find themselves trapped between the bed and wall, or inclined roof wall, ceiling, adjacent pieces of furniture (such as cupboards) or other items.
To avoid any risk of serious injury, the distance between the upper safety barrier and surrounding items should not exceed 75 mm - or the distance should be greater than 230 mm.
- d) **WARNING** Do not use the upper bunk bed or a raised bed if a part of the structure is missing or broken. Spare parts should be requested from the manufacturer or shop.
- e) It is essential that the manufacturer's instructions on assembly and use are followed.
- f) The recommended size of the mattress to be used with the bed is 1900mm x 900mm, Maximum mattress thickness: 159mm,
- g) Mattresses must be aired to maintain a low humidity and to stop moisture building up in the bed and its surroundings.
- k) The fastenings put in place on assembly should all be properly tightened and regularly checked. Retighten the fastenings as necessary.
- l) This complies with the requirements of the European Safety Standard NF EN 747+A1: 2015.
- m) The presence of a night light could give more safety for a child sleeping in an upper bed.

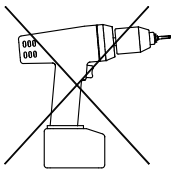

Tools needed (not supplied)

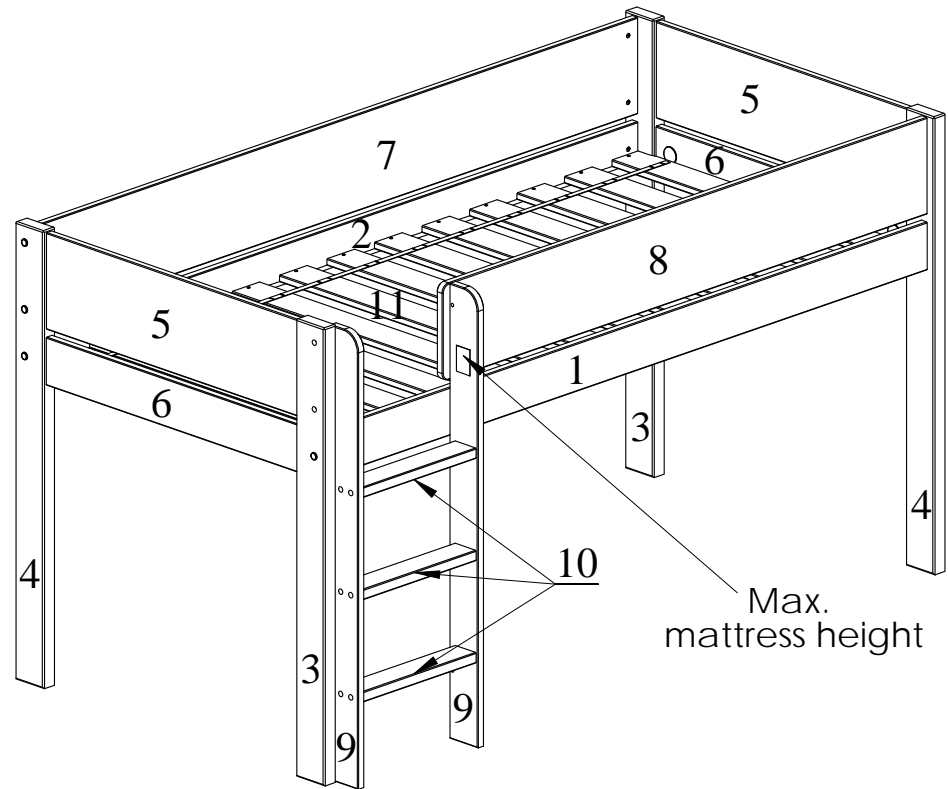
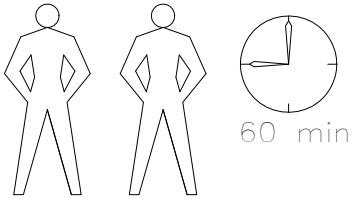
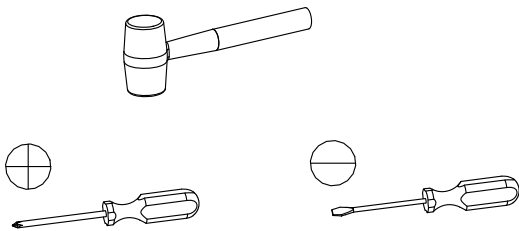

Ladder can be fitted right or left side.

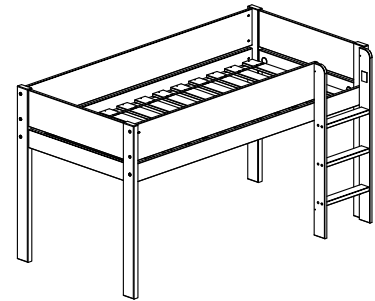

A		8x40	x34
B		D35	x4
C		7x60	x4
D		7x50	x12
E		M6x75	x10
F		D6x10x13	x10
G		55/12,5x5	x4
H		3,5x40	x26
J		4,2x35	x1

S		5x38	x1
K		D35	x4
L		D4x13	x12
M		D8x13	x6
N		D15x18	x10
P		D5x8	x4
Q		4mm	x1
R		GLUE	x1

①

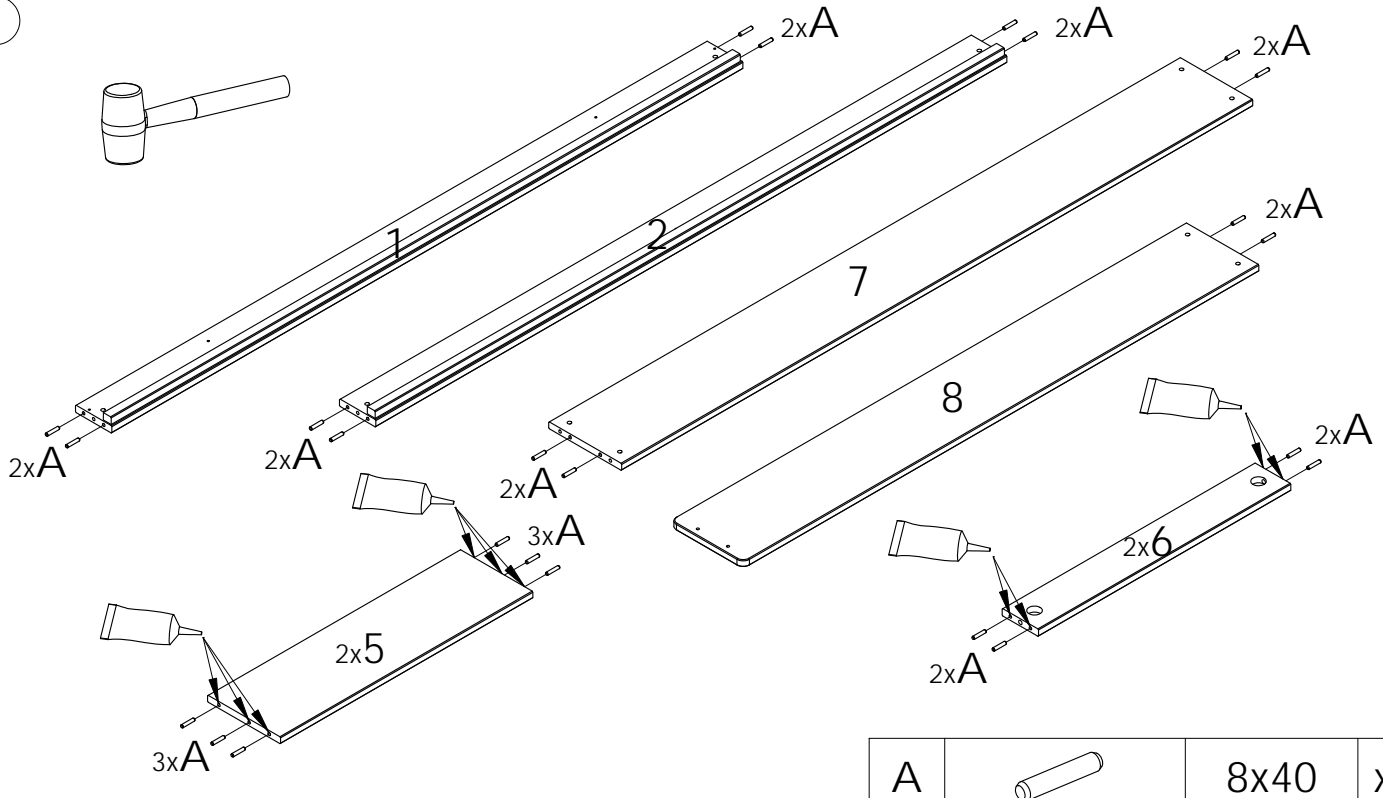

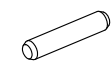
A		8x40	x34
---	---	------	-----

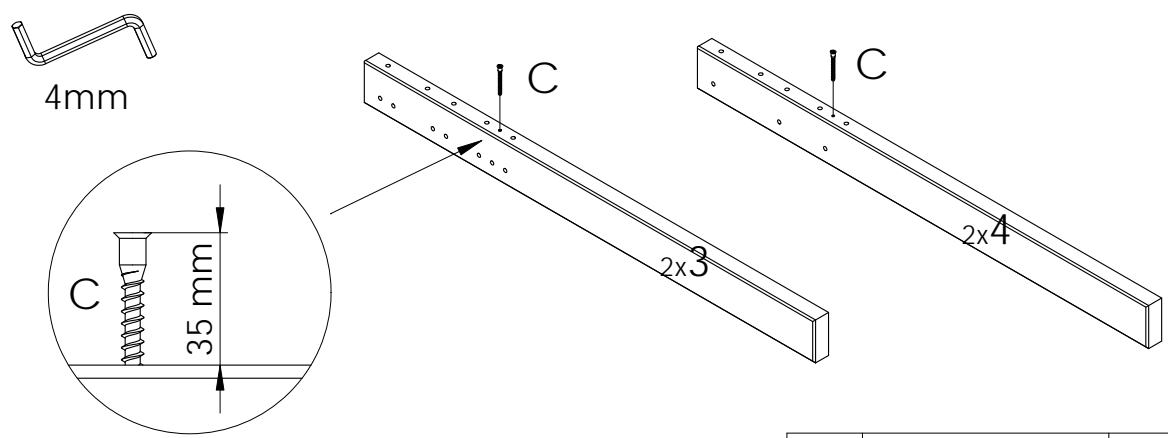

②

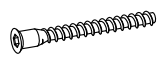

C		7x60	x4
---	---	------	----

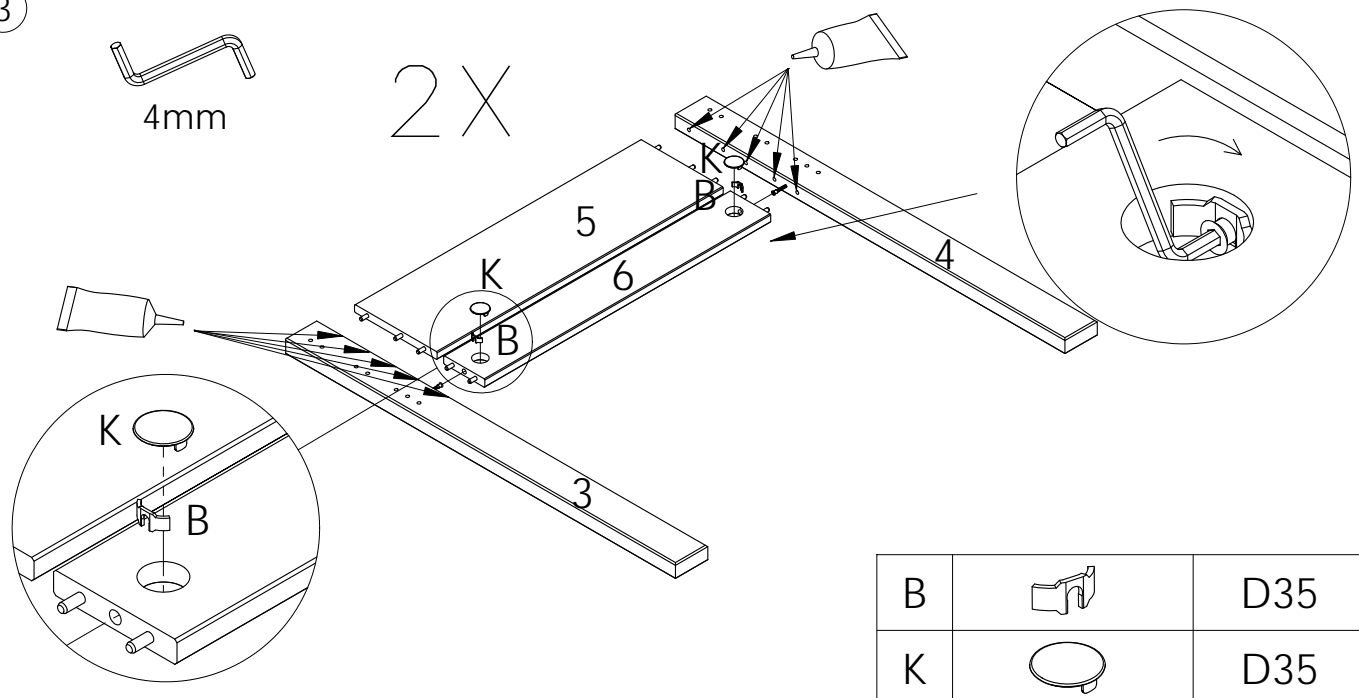
③



B		D35	x4
K		D35	x4

4

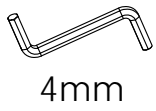

Always placed inside the ladder

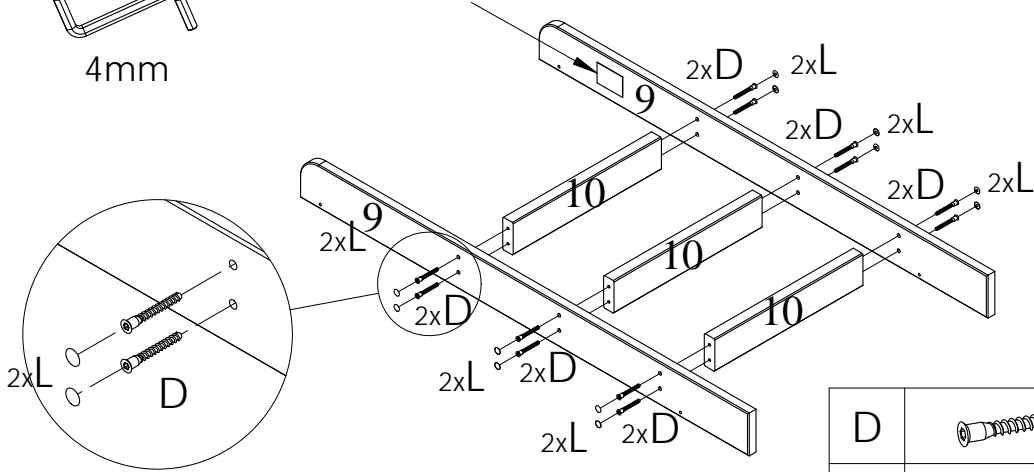

D		7x50	x12
L		D4x13	x12

5

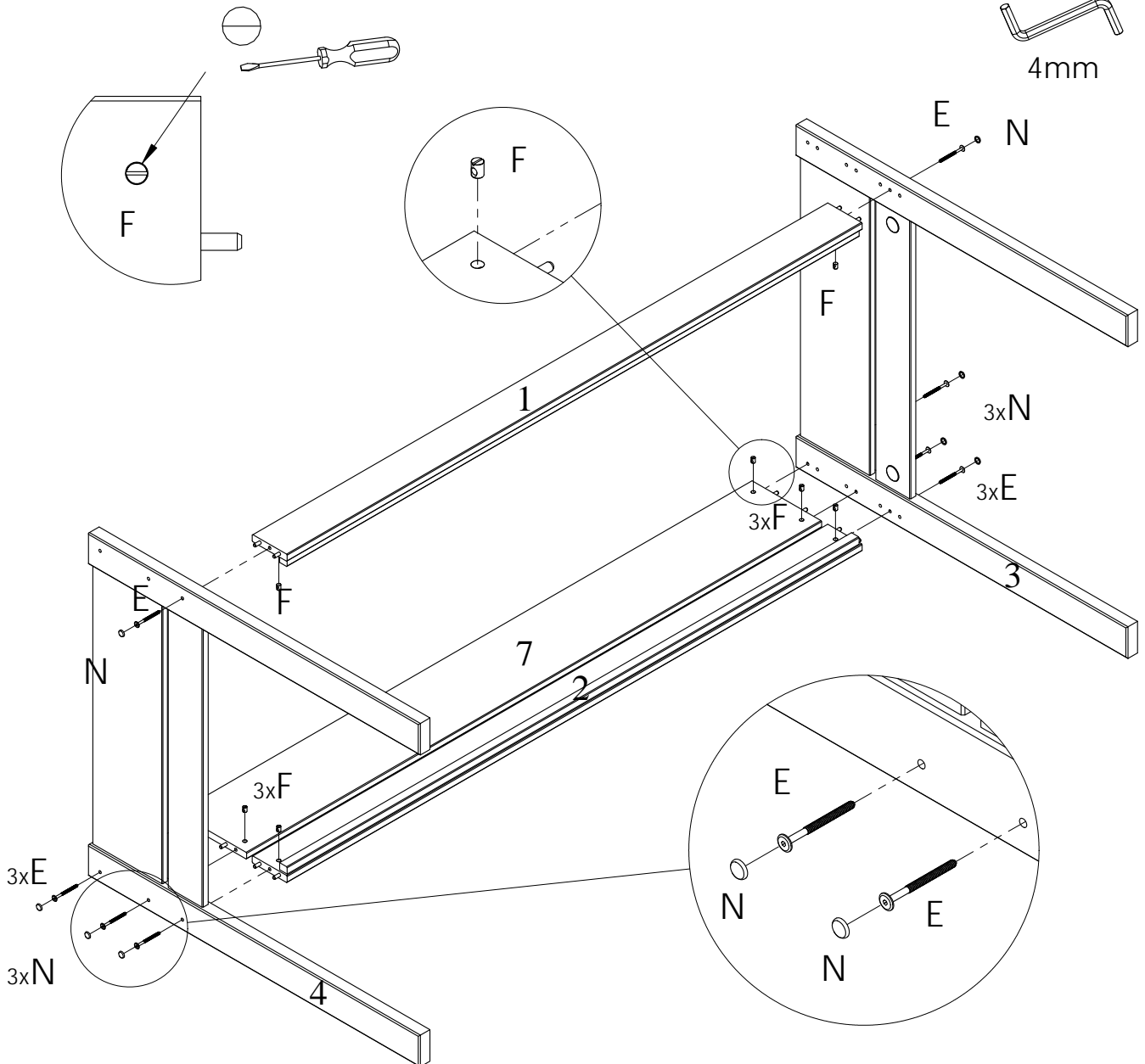
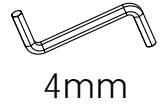
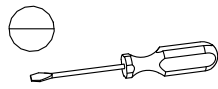



E		M6x75	x8
F		M6x10x13	x8

N		D15x18	x8
---	--	--------	----

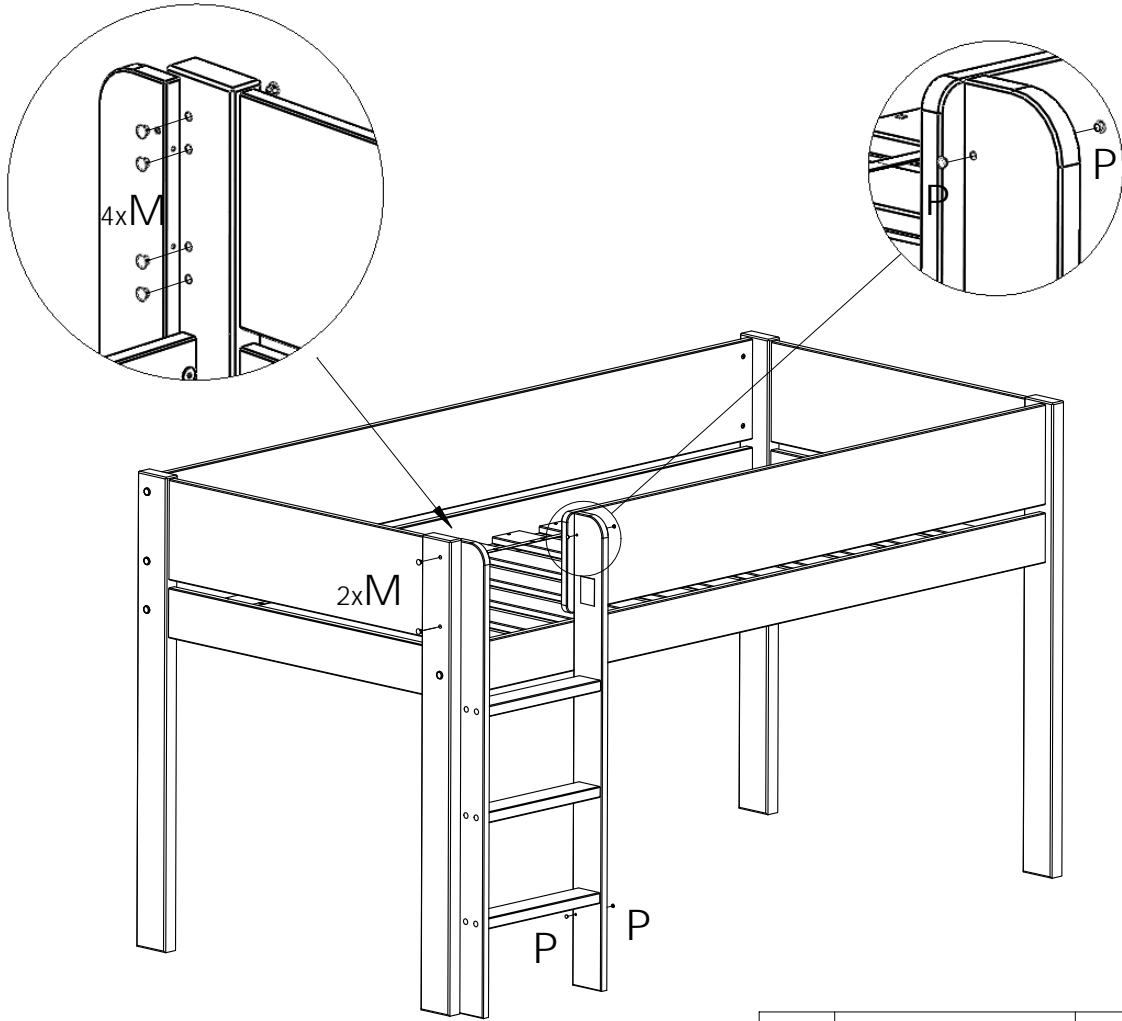
8



P		D5x8	x4
M		D8x13	x6