

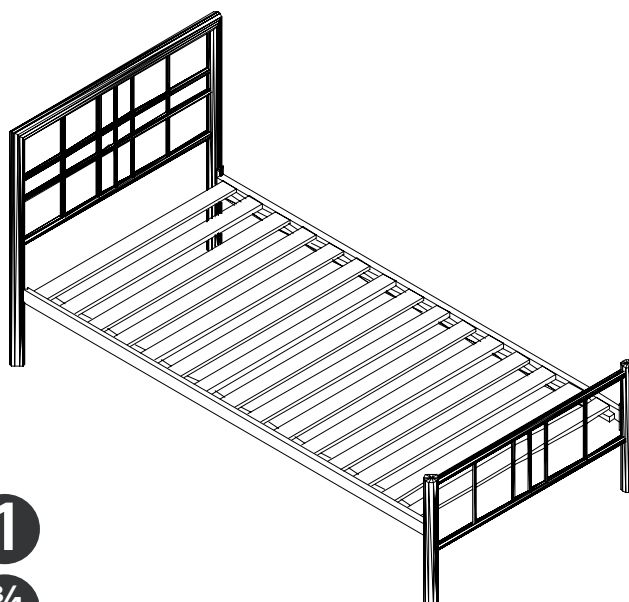

QUEST BED

213-00050

Assembly Instructions



Minimum No. of people recommended to assemble this product:

1

Approx assembly time:

3/4
hour





NOTE: Assembly should be carried out in the room that the bed will be used in.

Before you start, here is some helpful advice

1. We suggest you spend a short time reading through this leaflet and then follow the simple step by step instructions.
2. If you follow the instructions carefully the end result should be worth the effort.
3. Do not discard any of the packaging until you have checked that you have all the parts and the pack of fittings.
4. Assemble this product on a carpet.
5. To ensure an easier assembly, we strongly advise that all fittings are only finger tightened during initial assembly. Only upon completion of the assembly should all fixing points be fully tightened.
6. We recommend a periodic check on all fixing points to make sure they remain fully tightened.
7. Keep fittings out of children's reach.

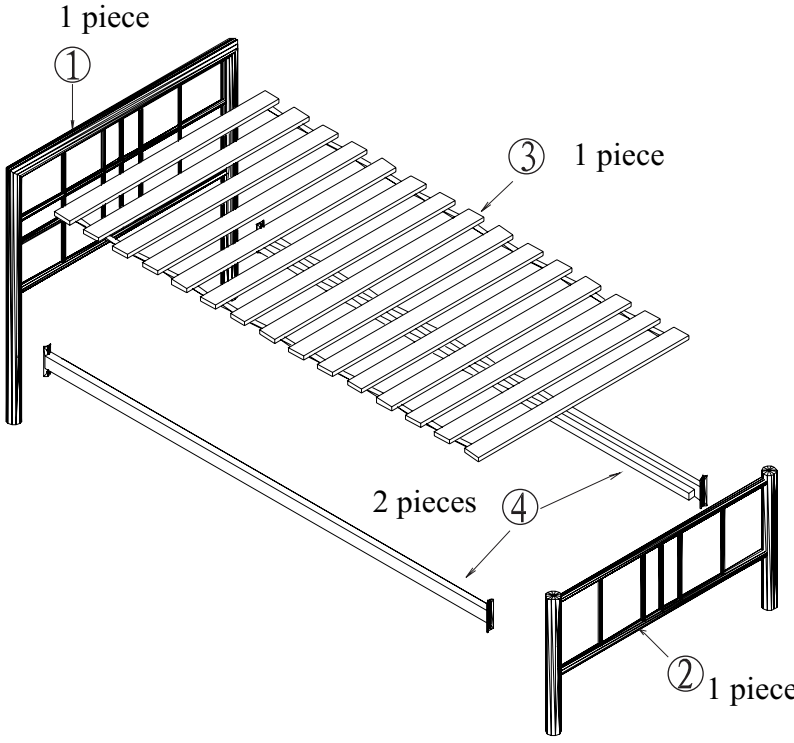
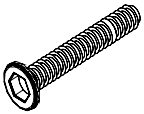
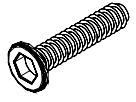
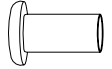
In the unlikely event that this product has missing or damaged parts, please call 0870 3333 612 to obtain spares.

Component parts and fittings contained in the box

PARTS	Fittings
 <p>1 piece</p> <p>①</p> <p>③ 1 piece</p> <p>2 pieces</p> <p>④</p> <p>② 1 piece</p>	<p>A</p> <p>M8x25mm 8pcs</p> 
	<p>B</p> <p>1/4" x3/4" mm 4pcs</p> 
	<p>C</p> <p>1/4" x8/7" mm 4pcs</p> 
	<p>D</p> <p>Washer 8pcs</p> 
	<p>E</p> <p>Spring washer 8pcs</p> 
	<p>E</p> <p>4MM Allen key 2pcs</p> 
	<p>G</p> <p>5MM Allen key 1pc</p> 

ASSEMBLY

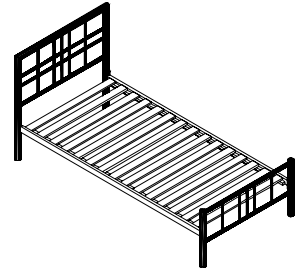

1) Connect the headboard **1**, footboard **2** and side rail **4** using the Washer **D**, spring washer **E** and bolts **A**.

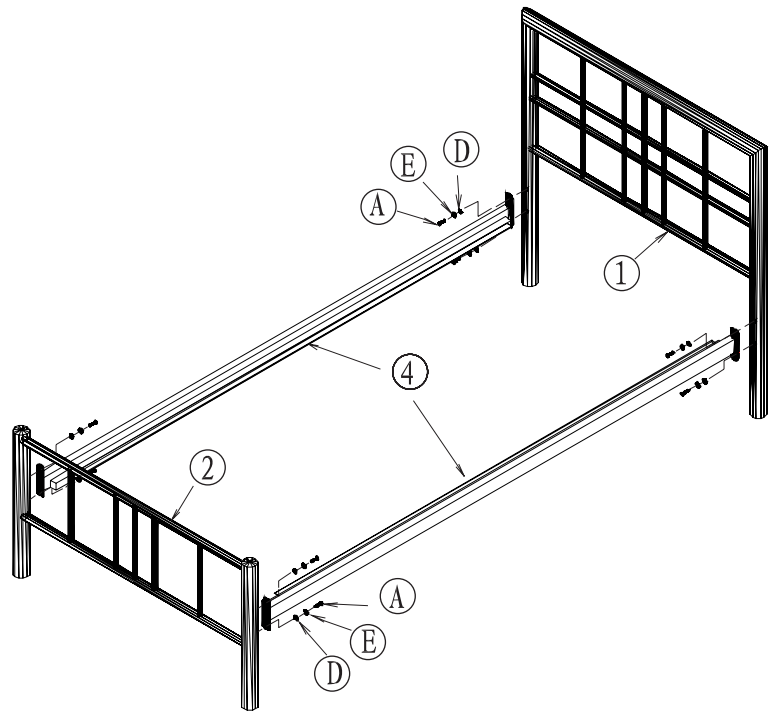

1) Connect the bed frame **3** and side-Rail **4** using the bolts **B** and JCN-Nut **C**.

